

• AC/DC Converter •

# Catalogue 2015

**ZimTec Electronics GmbH**

Franz-Mehring-Weg 2, 39606 Osterburg  
Tel.: 03937 2925110 Fax: 03937 2925112

[www.zimtec-electronics.de](http://www.zimtec-electronics.de)  
[info@zimtec-electronics.de](mailto:info@zimtec-electronics.de)

# AC/DC Converter



- High isolation
- Low consumption
- Meet RoHS, CE, UL standard
- Multiple protection: over current, over voltage
- High efficiency
- Low ripple and noise



## AC/DC WIDE/UNIVERSAL INPUT, HIGH-ISOLATION

Product Series	Watt	Input Voltage (VDC)	Output Voltage (VDC)	Isolation	Package Style / Note
DZS01(-F)	1W	85 ~ 264VAC, 70 ~ 400VDC	5, 9, 12, 15, 24	3KV	Wide input, Short circuit protection, Efficiency up to 84%
DZS03-R2(-F)	1.65W	85 ~ 264VAC, 70 ~ 400VDC	3.3	3KV	Universal input, Short circuit protection, Efficiency up to 78%
	2.5W		5		
	3W		9, 12, 15, 24		
DZS05(-F)	3W	85 ~ 264VAC, 100 ~ 400VDC	3.3	3KV	Wide input, Short circuit protection, Efficiency up to 75%
	5W		5, 9, 12, 15, 24		
DZH05-10A	5W	85 ~ 264VAC, 120 ~ 370VDC	+5/-5, +12/-12, +15/-15, +24/-24	3KV	Universal input, Efficiency up to 85%
DZH05-10B			3.3, 5, 9, 12, 15, 24		
DZH10-10A	10W	85 ~ 264VAC, 120 ~ 370VDC	+5/-5, +12/-12, +15/-15, +24/-24	3KV	Universal input, Efficiency up to 84%
DZH10-10B			3.3, 5, 9, 12, 15, 24		
DZH15-10A	15W	85 ~ 264VAC, 120 ~ 370VDC	+5/-5, +12/-12, +15/-15, +24/-24	3KV	Universal input, Efficiency up to 85%
DZH15-10B			3.3, 5, 9, 12, 15, 24, 48		
DZH20-10A	20W	85 ~ 264VAC, 120 ~ 370VDC	+5/-5, +12/-12, +15/-15	3KV	Universal input, Efficiency up to 85%
DZH20-10B			3.3, 5, 9, 12, 15, 24, 48		
DZH25-10B	25W	85 ~ 264VAC, 120 ~ 370VDC	3.3, 5, 9, 12, 15, 24, 48	3KV	Universal input, Efficiency up to 85%
DZH40-10A	40W	85 ~ 264VAC, 120 ~ 370VDC	+5/-5, +12/-12,	3KV	Wide input, Efficiency up to 84%
DZH40-10B			3.3, 5, 9, 12, 15, 24		
DZH60-20B	60W	90 ~ 264VAC, 120 ~ 370VDC	5, 9, 12, 15, 24, 48	3KV	Wide input, Efficiency up to 86%

# Contents

DZS01(-F) - 1W Series .....	2
DZS03-R2(-F) - 3W Series .....	5
DZS05(-F) - 5W Series .....	8
DZH05-25 - 5 - 25W Series .....	11
DZH40 - 40W Series .....	18
DZH60 - 60W Series .....	22

## Über uns

### ZimTec Electronics GmbH

„Wir“ - die Firma ZimTec Electronics GmbH sind ein junges und innovatives mittelständisches Elektronik-Unternehmen aus dem Herzen der Altmark in Sachsen-Anhalt.

Unser Service ist Ihr Vorteil, denn als Hersteller mit eigenem Direktvertrieb bieten wir Ihnen qualitativ hochwertige DC/DC und AC/DC Spannungswandler an.

Unser umfangreiches Sortiment umfasst DC/DC Spannungswandler in den Leistungsbereichen von 0,5 bis 40 Watt in den Bauformen SMD, SIP und DIP sowie AC/DC Spannungswandler und Schaltnetzteile von 1 bis 60 Watt.

Spannungswandler von ZimTec Electronics sind für höchste Ansprüche geschaffen und finden Ihren Einsatz in den Bereichen Steuerungselektronik, Medizin- und Bahntechnik und überall da, wo Qualität und Zuverlässigkeit benötigt werden!

Wir stehen Ihnen als zuverlässiger Partner bei Ihren Projekten und Neuentwicklungen zur Seite und unterstützen Sie auch gerne mit kostenlosen Mustern oder fertigen für Sie individuell angepasste Spannungswandler nach Ihren Vorgaben und Parametern an.

Scheuen Sie sich nicht, uns zu kontaktieren, unser Team steht Ihnen selbstverständlich bei Fragen zur Verfügung.

ZimTec Electronics GmbH  
Franz-Mehring-Weg 2  
39606 Osterburg

[www.zimtec-electronics.de](http://www.zimtec-electronics.de)  
[info@zimtec-electronics.de](mailto:info@zimtec-electronics.de)

Tel.: 03937 - 2925110  
Fax: 03937 - 2925112

# DZS01(-F) Series

## 1W AC/DC Converter

### Features

- Wide input voltage:85 ~ 264VAC(70 ~ 400VDC)
  - Over current protection and short circuit protection
  - High efficiency, high density
  - Low loss, green power
  - Industrial design
  - Ultra-Miniature package
  - 90 degree curved series, minimizing product height
- Certificate UL60950/EN60950 standards

INPUT SPECIFICATIONS					
Item	Test Conditions	Min.	Typ.	Max.	Unit
Input Voltage Range	AC Input	85	--	264	V
	DC Input	70	--	400	
Input Frequency		47	--	440	Hz
Input Current	115VAC	--	--	0.12	A
	230VAC	--	--	0.04	
Inrush Current	115VAC	--	10	--	
	230VAC	--	20	--	

OUTPUT SPECIFICATIONS					
Item	Test Conditions	Min.	Typ.	Max.	Unit
Output Voltage Accuracy	DZS01-15B05S(-F)	--	--	±10.0	%
	DZS01-15B09S(-F)				
	DZS01-15B12S(-F)	--	--	±5.0	
	DZS01-15B15S(-F)				
	DZS01-15B24S(-F)				
Line Regulation	full load	--	±1.5	--	
Load Regulation	5% to 100%	--	±2.5	--	
Ripple & Noise(p-p) 20MHz bandwidth	DZS01-15B05S(-F)				mV
	DZS01-15B09S(-F)				
	DZS01-15B12S(-F)	--	50	120	
	DZS01-15B15S(-F)				
	DZS01-15B24S(-F)				
Min Load		5	--	--	%
Hold-up Time	115VAC	80	--	--	ms
	230VAC	300	--	--	
Short Circuit Protection		Continuous, and auto recovery			
Over Current Protection		Auto recovery			

EMC SPECIFICATIONS					
EMI	CE	CISPR22/EN55022, CLASS A (Typical Application Circuit Refer to Figure 1)			
		CISPR22/EN55022, CLASS B (Recommended Circuit Refer to Figure 3)			
	RE	CISPR22/EN55022, CLASS A (Typical Application Circuit Refer to Figure 1)			
		CISPR22/EN55022, CLASS B (Recommended Circuit Refer to Figure 3)			
EMS	ESD	IEC/EN61000-4-2 Contact ±4KV			perf. Criteria B
	RS	IEC/EN61000-4-3 10V/m (Recommended Circuit Refer to Figure 3)			perf. Criteria A
	EFT	IEC/EN61000-4-4 ±2KV (Typical Application Circuit Refer to Figure 1)			perf. Criteria B
		IEC/EN61000-4-4 ±4KV (Recommended Circuit Refer to Figure 3)			perf. Criteria B
	Surge	IEC/EN61000-4-5 ±1KV/±2KV (Recommended Circuit Refer to Figure 3)			perf. Criteria B
	CS	IEC/EN61000-4-6 3 Vr.m.s (Recommended Circuit Refer to Figure 3)			perf. Criteria A
	PFM	IEC/EN61000-4-8 10A/m			perf. Criteria A
	Voltage dips, short and interruptions immunity	IEC/EN61000-4-11 0%-70%			perf. Criteria B

**DZS01 (-F) Series - 1W AC/DC Converter**

COMMON SPECIFICATIONS						
Item	Test Conditions		Min.	Typ.	Max.	Unit
Operating Temperature			-40	--	+85	°C
Storage Temperature			-40	--	+105	
Case temperature			--	--	+90	
Storage Humidity			--	--	85	%RH
Temperature coefficient			--	±0.1	--	% / °C
Power derating	-40°C ~ -20°C		1	--	--	
	+55°C ~ +85°C		0.67	--	--	
Isolation Resistance			100	--	--	MΩ
Isolation Voltage	input-output	Tested for 1 minute	3000	--	--	VAC
Switching Frequency			--	--	50	kHz
Weight			--	8	--	g
Welding Temperature	Wave-soldering		260 ± 5°C; time:5~10s			
	Manual-welding		360 ± 10°C; time:3~5s			
Safety approvals			UL60950/EN60950			
Safety Class			CLASS II			
Safety standards			UL60950/EN60950			
Hot swap			Forbid			
Case Material Grade			UL 94V-0			
Install			PCB			
Cooling			Free air convection			
MTBF			>300,000 h @ 25°C			

Note: 1. External electrolytic capacitors are required to modules, more details refer to typical applications.  
 2. Ripple and Noise measuring refer to "ripple and noise measure figure".  
 3. All specifications were measured at Ta=25°C, humidity<75%, nominal input voltage (115VAC or 230VAC) and rated output load unless otherwise specified.  
 4. In this datasheet, all the test methods of indications are based on corporate standards.  
 5. Module required dispensing fixed after assembled.

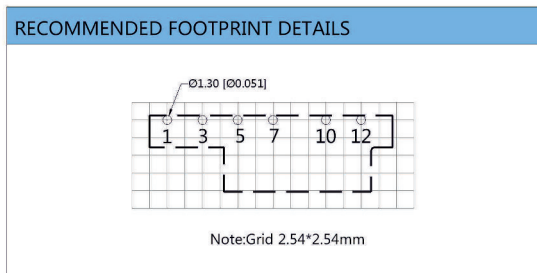
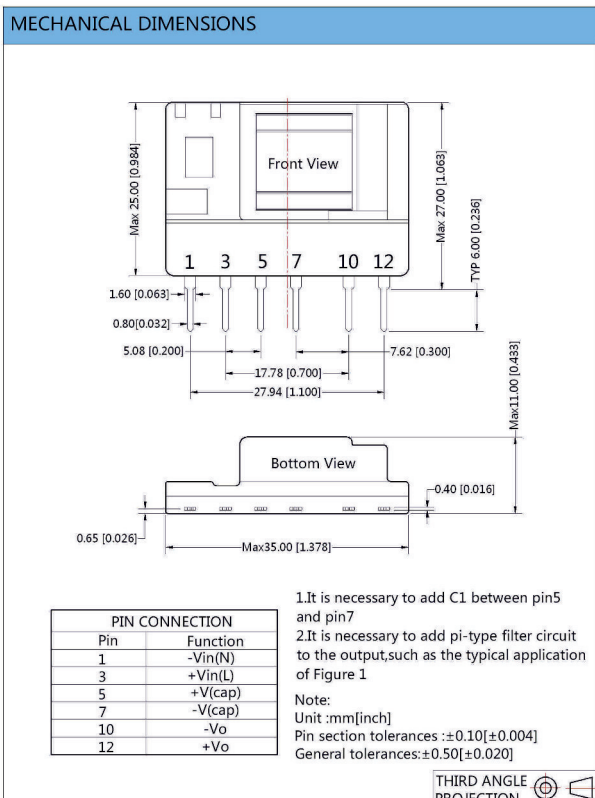
**MECHANICAL SPECIFICATIONS**
**DZS01 DIMENSIONS, RECOMMENDED FOOTPRINT**

DZS01 (-F) Series - 1W AC/DC Converter

**MECHANICAL SPECIFICATIONS**

**DZS01-F DIMENSIONS, RECOMMENDED FOOTPRINT**

**MECHANICA DIMENSIONS**

**FRONT VIEW DIMENSIONS:**  
 Max 35.00 [1.378]  
 Max 25.00 [0.984]  
 Pin positions: 1, 3, 5, 7, 10, 12

**RIGHT VIEW DIMENSIONS:**  
 Max 3.00 [0.118]  
 0.40 [0.016]

**BOTTOM VIEW DIMENSIONS:**  
 1.60 [0.063]  
 0.80 [0.031]  
 5.08 [0.200]  
 17.78 [0.700]  
 27.94 [1.100]  
 7.62 [0.300]  
 6.00 [0.236]

PIN CONNECTION	
Pin	Function
1	-Vin ( N )
3	+Vin ( L )
5	+V(cap)
7	-V(cap)
10	-Vo
12	+Vo

1.It is necessary to add C1 between pin5 and pin7 ;  
 2.It is necessary to add pi-type filter circuit to the output,such as the typical application of Figure 1.

Note:  
 Unit :mm[inch]  
 Pin section tolerances :±0.10[±0.004]  
 General tolerances:±0.50[±0.020]

THIRD ANGLE PROJECTION

**RECOMMENDED FOOTPRINT DETAILS**

Note:Grid 2.54\*2.54mm  
 01.30 [00.051]

**MODEL SELECTION GUIDE**

Approval	Model	Power	Output (Vo/Io)	Max. Capacitive Load (µF)	Ripple and Noise (Max.)	Efficiency (%) (230VAC,Typ.)	Standby Power(Max.)
UL/CE (beside "-F")	DZS01-15B05S(-F)*	1W	5V/200mA	220	120mV	66	0.5W
	DZS01-15B09S(-F)		9V/111mA	100		67	
	DZS01-15B12S(-F)		12V/83mA	100		70	
	DZS01-15B15S(-F)		15V/67mA	100		69	
	DZS01-15B24S(-F)		24V/42mA	100		68	

Note: \*The model of 90 degrees of corner is with F. For example the DZS01-15B12S of 90 degrees of corner product is DZS01-15B12S-F.

# DZS03-R2(-F) Series

## 3W AC/DC Converter

### Features

- Wide input voltage:85 ~ 264VAC(70 ~ 400VDC)
  - Over current protection and short circuit protection
  - High efficiency, high density
  - Low loss, green power
  - Industrial design
  - Ultra-Miniature package
  - 90 degree curved series, minimizing product height
- Certificate UL60950/EN60950 standards

INPUT SPECIFICATIONS					
Item	Test Conditions	Min.	Typ.	Max.	Unit
Input Voltage Range	AC Input	85	--	264	V
	DC Input	100	--	400	
Input Frequency		47	--	440	Hz
Input Current	115VAC	--	--	0.12	A
	230VAC	--	--	0.06	
Inrush Current	115VAC	--	20	--	
	230VAC	--	40	--	

OUTPUT SPECIFICATIONS					
Item	Test Conditions	Min.	Typ.	Max.	Unit
Output Voltage Accuracy	DZS03-15B03SR2(-F)	--	--	±3.0	%
	DZS03-15B05SR2(-F)*	--	--	±5.0	
	DZS03-15B09SR2(-F)	--	--	±8.0	
	DZS03-15B12SR2(-F)	--	--	±5.0	
	DZS03-15B15SR2(-F)	--	--	±5.0	
	DZS03-15B24SR2(-F)	--	--	±5.0	
Line Regulation	full load	DZS03-15B03SR2(-F)	--	±0.5	--
		Other model	--	±1.5	--
Load Regulation	10% to 100%	DZS03-15B03SR2(-F)	--	±1.5	--
		Other model	--	±2.5	--
Ripple & Noise(p-p) 20MHz bandwidth (measuring refer to "ripple and noise measure figure")	DZS03-15B03SR2(-F)	--	70	--	mV
	DZS03-15B05SR2(-F)	--	70	--	
	DZS03-15B09SR2(-F)	--	70	--	
	DZS03-15B12SR2(-F)	--	50	--	
	DZS03-15B15SR2(-F)	--	50	--	
Min Load		10	--	--	%
Hold-up Time	115VAC	60			ms
	230VAC	300			
Short Circuit Protection		Continuous, and auto recovery			
Over Current Protection		Auto recovery			

Note : DZS03-15B05SR2(-F)\* (-20°C~40°C and 55°C~85°C:Figure 1 Output sloid capacitance C2: 270µF/16V).

### DZS03-R2(-F) Series - 3W AC/DC Converter

COMMON SPECIFICATIONS					
Item	Test Conditions	Min.	Typ.	Max.	Unit
Operating Temperature		-40	--	+85	°C
Storage Temperature		-40	--	+105	
Case temperature		--	--	+90	
Storage Humidity		--	--	85	%RH
Temperature coefficient		--	±0.15	--	% / °C
Power derating	-40°C~-20°C	2	--	--	
	+55°C~+85°C	1.33	--	--	
Isolation Resistance		100	--	--	MΩ
Isolation Voltage	input-output   Tested for 1 minute	3000	--	--	VAC
Switching Frequency	DZS03-15B03SR2(-F)	--	100	--	kHz
	Other model	--	--	50	
Weight		--	8	--	g
Welding Temperature	Wave-soldering	260± 5°C ; time:5~10s			
	Manual-welding	360± 10°C; time:3~5s			
Safety approvals		UL60950/EN60950			
Safety Class		CLASS II			
Safety standards		UL60950/EN60950			
Hot swap		Forbid			
Case Material Grade		UL 94V-0			
Install		PCB			
Cooling		Free air convection			
MTBF		>300,000 h @ 25°C			

Note: 1. External electrolytic capacitors are required to modules, more details refer to typical applications.  
 2. Ripple and Noise measuring refer to "ripple and noise measure figure".  
 3. All specifications were measured at Ta=25°C, humidity<75%, nominal input voltage (115VAC or 230VAC)and rated output load unless otherwise specified.  
 4. In this datasheet, all the test methods of indications are based on corporate standards.

EMC SPECIFICATIONS			
EMI	CE	CISPR22/EN55022, CLASS A (Typical Application Circuit Refer to Figure 1)	
		CISPR22/EN55022, CLASS B (Recommended Circuit Refer to Figure 3)	
	RE	CISPR22/EN55022, CLASS A (Typical Application Circuit Refer to Figure 1)	
		CISPR22/EN55022, CLASS B (Recommended Circuit Refer to Figure 3)	
EMS	ESD	IEC/EN61000-4-2	Contact ±4KV perf. Criteria B
	RS	IEC/EN61000-4-3	10V/m (Recommended Circuit Refer to Figure 3) perf. Criteria A
	EFT	IEC/EN61000-4-4 ±2KV (Typical Application Circuit Refer to Figure 1) perf. Criteria B	
		IEC/EN61000-4-4 ±4KV (Recommended Circuit Refer to Figure 3) perf. Criteria B	
	Surge	IEC/EN61000-4-5	±1KV/±2KV (Recommended Circuit Refer to Figure 3) perf. Criteria B
	CS	IEC/EN61000-4-6	3 Vr.m.s (Recommended Circuit Refer to Figure 3) perf. Criteria A
	PFM	IEC/EN61000-4-8	10A/m perf. Criteria A
Voltage dips, short and interruptions immunity	IEC/EN61000-4-11	0%-70%	perf. Criteria B

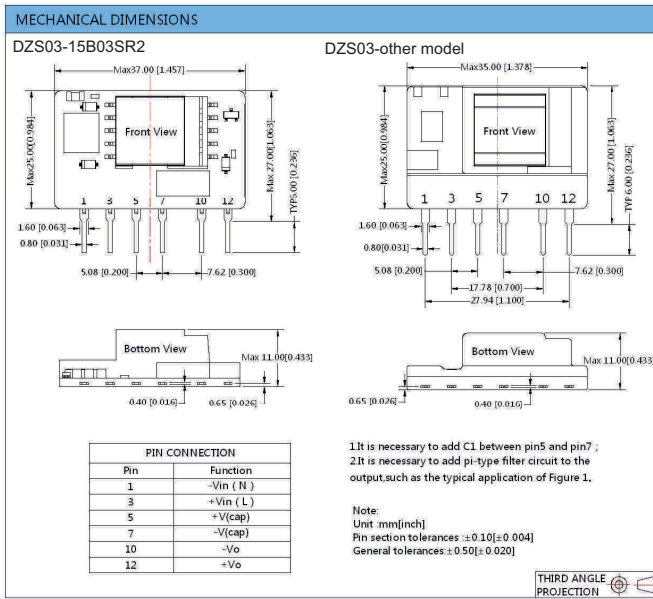
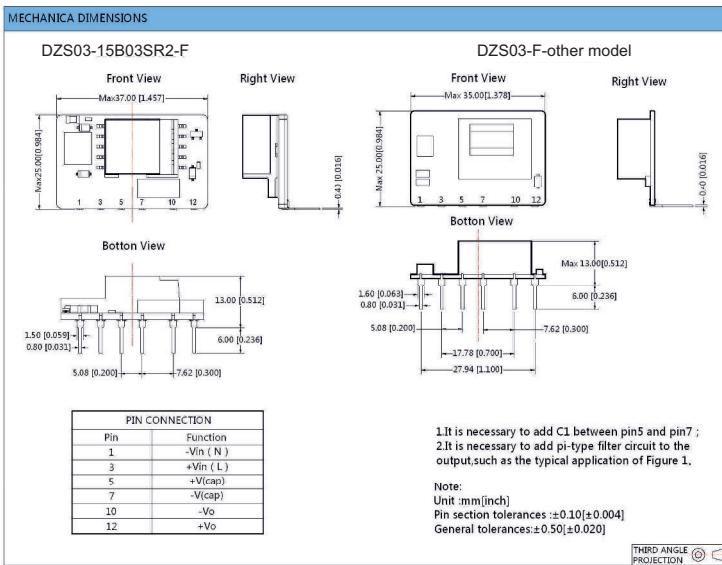

**DZS03-R2(-F) Series - 3W AC/DC Converter**
**MECHANICAL SPECIFICATIONS**
**DZS03-R2 DIMENSIONS, RECOMMENDED FOOTPRINT**

**DZS03-R2-F DIMENSIONS, RECOMMENDED FOOTPRINT**

**MODEL SELECTION GUIDE**

Approval	Model	Power	Output (Vo/Io)	Max. Capacitive Load (µF)	Ripple and Noise (Max.)	Efficiency (%) (230VAC, Typ.)	Standby Power(Max.)
--	DZS03-15B03SR2(-F)*	1.65W	3.3V/500mA	2300	150mV	66	0.5W
UL/CE (beside "-F")	DZS03-15B05SR2(-F)	3W	5V/500mA	470	150mV	69	
	DZS03-15B09SR2(-F)		9V/333mA	150	120mV	76	
	DZS03-15B12SR2(-F)		12V/250mA	100	120mV	78	
	DZS03-15B15SR2(-F)		15V/200mA	100	120mV	78	
	DZS03-15B24SR2(-F)		24V/125mA	100	120mV	78	

Note: \*The model of 90 degrees of corner is with F. For example the DZS03-15B12SR2 of 90 degrees of corner product is DZS03-15B12SR2-F.

# DZS05(-F) Series

## 5W AC/DC Converter

### Features

- Wide input voltage:85 ~ 264VAC(70 ~ 400VDC)
- Over current protection and short circuit protection
- High efficiency, High security isolation: 3000VAC
- Industrial design
- Ultra-Miniature package
- 90 degree curved series, minimizing product height
- Certificate UL60950/EN60950 standards

INPUT SPECIFICATIONS					
Item	Test Conditions	Min.	Typ.	Max.	Unit
Input Voltage Range	AC Input	85	--	264	V
	DC Input	100	--	400	
Input Frequency		47	--	440	Hz
Input Current	115VAC	--	--	0.2	A
	230VAC	--	--	0.1	
Inrush Current	115VAC	--	20	--	
	230VAC	--	30	--	
leakage Current	CY0 is 1nF/400VAC	--	--	0.25	mA

OUTPUT SPECIFICATIONS					
Item	Test Conditions	Min.	Typ.	Max.	Unit
Output Voltage Accuracy	DZS05-15B03S(-F)	--	±2.0	±3.0	%
	DZS05-15B05S(-F)	--	±1.0	±2.0	
	DZS05-15B09S(-F)	--			
	DZS05-15B12S(-F)	--			
	DZS05-15B15S(-F)	--			
	DZS05-15B24S(-F)	--			
Line Regulation	full load	--	±0.1	±0.5	
Load Regulation	10% to 100%	--	±1.0	±1.5	
Ripple & Noise(p-p) (measuring refer to "RIPPLE AND NOISE MEASURE FIGURE")	20MHz bandwidth	--	50	150	mV
Min Load		10	--	--	%
Hold-up Time	115VAC	20	--	--	ms
	230VAC	80	--	--	
Short Circuit Protection		Continuous, and auto recovery			
Over Current Protection		≥110% I <sub>o</sub> , Auto recovery			
Over Voltage Protection		Zener diode clamp			

EMC SPECIFICATIONS		
EMI	CE	CISPR22/EN55022, CLASS A (with typical applications Figure 1)
		CISPR22/EN55022, CLASS B (with typical applications Figure 3)
	RE	CISPR22/EN55022, CLASS B (with typical applications Figure 1 or Figure 3)
EMS	ESD	IEC/EN61000-4-2 Contact ±4KV perf. Criteria B
	RS	IEC/EN61000-4-3 10V/m perf. Criteria A
	EFT	IEC/EN61000-4-4 ±2KV (with typical applications Figure 1) perf. Criteria B
		IEC/EN61000-4-4 ±4KV (with typical applications Figure 3) perf. Criteria B
	Surge	IEC/EN61000-4-5 ±1KV/±2KV (with typical applications Figure 3) perf. Criteria B
	CS	IEC/EN61000-4-6 3 Vr.m.s (with typical applications Figure 3) perf. Criteria A
	PFM	IEC/EN61000-4-8 10A/m perf. Criteria A
Voltage dips, short and interruptions immunity	IEC/EN61000-4-11 0%-70% perf. Criteria B	

**DZS05(-F) Series - 5W AC/DC Converter**

COMMON SPECIFICATIONS						
Item	Test Conditions		Min.	Typ.	Max.	Unit
Operating Temperature			-25	--	+85	°C
Storage Temperature			-40	--	+105	
Surface temperature			--	--	+100	
Storage Humidity			--	--	85	%RH
Temperature coefficient			--	±0.02	--	% / °C
Power derating	-25°C ~ +0°C		0.8	--	--	
	+55°C ~ +85°C		1.33	--	--	
Isolation Resistance			100	--	--	MΩ
Isolation Voltage	input-output	Tested for 1 minute(leakage current setting value:5 mA)	3000	--	--	VAC
Switching Frequency			--	100	--	kHz
Weight			--	10	--	g
Welding Temperature	Wave-soldering		260 ± 5°C ; time:5~10s			
	Manual-welding		360 ± 10°C ; time:3~5s			
Safety approvals			EN60950/UL60950			
Safety Class			CLASS II			
Safety standards			IEC60950/EN60950/UL60950			
Hot swap			Forbid			
Install			PCB			
Cooling			Free air convection			
MTBF			>300,000 h @ 25°C			

Note: 1. External electrolytic capacitors are required to modules, more details refer to typical applications.  
 2. Ripple and Noise measuring refer to "RIPPLE AND NOISE MEASURE FIGURE".  
 3. All specifications were measured at Ta=25°C, humidity<75%, nominal input voltage(115VAC or 230VAC) and rated output load unless otherwise specified.  
 4. In this datasheet, all the test methods of indications are based on corporate standards.  
 5. When working under high vibration, the product need to be glued for fixing.

**MECHANICAL SPECIFICATIONS**
**DZS05-15BXXS DIMENSIONS, RECOMMENDED FOOTPRINT**

### MECHANICAL DIMENSIONS

**Front View**  
 Max. 42.00 [1.654]  
 Max. 27.00 [1.063]  
 Max. 23.00 [0.984]  
 Typ. 6.00 [0.236]  
 5.08 [0.200]  
 22.86 [0.900]  
 33.02 [1.300]  
 1.60 [0.063]  
 0.80 [0.031]

**Bottom View**  
 Max. 11.00 [0.433]  
 0.40 [0.016]  
 0.65 [0.026]

PIN CONNECTION	
Pin	Function
1	-Vin ( N )
3	+Vin ( L )
5	+V(cap)
7	-V(cap)
12	-Vo
14	+Vo

Note:  
 Unit :mm[inch]  
 Pin section tolerances :±0.1[±0.004]  
 General tolerances:±0.50[±0.020]

THIRD ANGLE PROJECTION

### RECOMMENDED FOOTPRINT DETAILS

Note : Grid 2.54\*2.54mm

1.It is necessary to add C1 between pin5 and pin7.  
 2.It is necessary to add Pi filter circuit to the output,such as the typical application of Figure 1.

DZS05(-F) Series - 5W AC/DC Converter

**MECHANICAL SPECIFICATIONS**

**DZS05-15BXXS-F DIMENSIONS, RECOMMENDED FOOTPRINT**

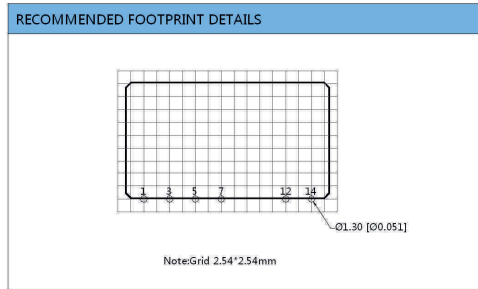
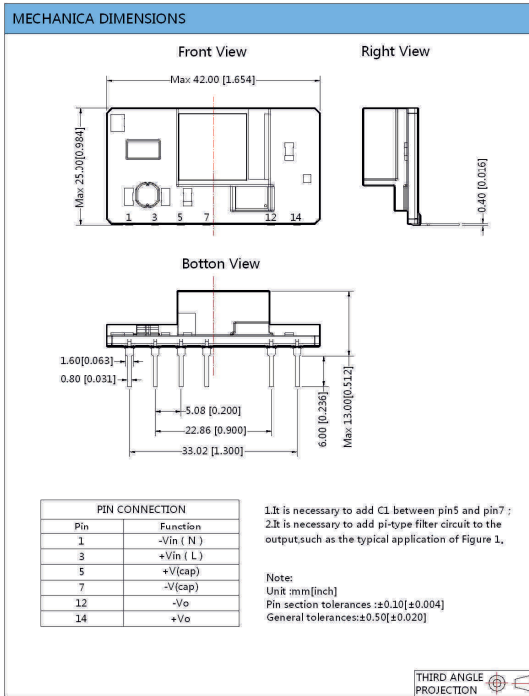

**MODEL SELECTION GUIDE**

Approval	Model	Power	Output (Vo/Io)	Max. Capacitive Load (µF)	Ripple and Noise (Max.)	Efficiency (%) (230VAC, Typ.)	Standby Power(Max.)
UL (beside "-F")	DZS05-15B03S(-F)*	3.3W	3.3V/1000mA	2200	150mV	65	0.5W
	DZS05-15B05S(-F)	5W	5V/1000mA	1500	120mV	70	
	DZS05-15B09S(-F)		9V/560mA	680	120mV	72	
	DZS05-15B12S(-F)		12V/420mA	470	120mV	74	
	DZS05-15B15S(-F)		15V/340mA	330	120mV	75	
	DZS05-15B24S(-F)		24V/210mA	100	150mV	75	

Note:\* The model of 90 degrees of corner is with F. For example the DZS05-15B12S of 90 degrees of corner product is DZS05-15B12S-F.

# DZH05-25 Series

## 5-25W AC/DC Converter

### Features

- Universal input range:85~264VAC, 50/60Hz
- Regulated output, low ripple and noise
- Efficiency up to 85%
- Over-current, short circuit and over-voltage protection
- Plastic case, meets UL94V-0
- Meet UL60950,EN60950 standards
- PCB mounting, Chassis mounting, DIN-Rail mounting

INPUT SPECIFICATIONS						
Item	Operating Conditions		Min.	Typ.	Max.	Unit
Input Voltage Range	AC input		87	-	264	VAC
	DC input		120	-	370	VDC
Input frequency			47	-	63	Hz
Input current	115VAC	DZH05 models	-	-	0.125	A
		DZH10 models	-	-	0.26	
		DZH15 models	-	-	0.37	
		DZH20models	-	-	0.6	
		DZH25 models	-	-	0.6	
	230VAC	DZH05 models	-	-	0.08	
		DZH10 models	-	-	0.16	
		DZH15 models	-	-	0.22	
		DZH20models	-	-	0.34	
		DZH25 models	-	-	0.34	
Inrush current	115VAC	DZH05 models	-	10	-	
		DZH10 models	-	10	-	
		DZH20 models	-	10	-	
		DZH20/ DZH25 models	-	16	-	
	230VAC	DZH05 models	-	20	-	
		DZH10 models	-	20	-	
		DZH15 models	-	20	-	
		DZH20/ DZH25 models	-	30	-	
Leakage current			0.3mA RMS typ./230VAC/50Hz			
Recommended External Input Fuse(Special package series include fuse)	DZH05 models		1A/250V, slow fusing			
	DZH10/DZH15 models		2A/250V, slow fusing			
	DZH20/ DZH25 models		3.15A/250V, slow fusing			
Hot Plug			Unavailable			

OUTPUT SPECIFICATIONS							
Item	Operating Conditions		Min.	Typ.	Max.	Unit	
Output Voltage Accuracy	Main circuit		-	±2	-	%	
Line Regulation	Full load	Main circuit	-	±0,5	-		
		Auxiliary circuit	-	±1,5	-		
Load Regulation	10%-100% load	Single output	-	±1	-		
		Dual output(balanced load)		-	±2		-
		Isolated triple output (balanced load)	Main circuit	-	±3		-
			Auxiliary circuit	-	±5	-	

## DZH05-25 Series - 5-25W AC/DC Converter

OUTPUT SPECIFICATIONS							
		Isolated and separated twin output (balanced load)	Main circuit	-	±3	-	
			Auxiliary circuit	-	±5	-	
Ripple & Noise*	20MHz bandwidth (peak-peak value)				50	150	mV
Temperature Coefficient	Main circuit				±0.02	-	%/°C
Short Circuit Protection	Continuous, self-recovery						
Over-current Protection	≥110%Io self-recovery						
Over-voltage Protection	Main circuit	3.3 / 5VDC Output		≤ 7.5VDC			
		9VDC Output		≤ 13VDC			
		12 /15VDC Output		≤ 20VDC			
		24VDC Output		≤ 30VDC			
		48VDC Output		≤ 60VDC			
Min. Load	Single output models			0	-	-	%
	Dual output models (balanced load)			10	-	-	
	Isolated and separated twin output (balanced load)			10	-	-	
	Isolated triple output (balanced load)			10	-	-	
Hold-up Time	115VAC input			-	15	-	ms
	230VAC input			-	80	-	
Note: * Ripple and noise are measured by "parallel cable" method, please see AC-DC Converter Application Notes for specific operation.							

GENERAL SPECIFICATIONS						
Item	Operating Conditions		Min.	Typ.	Max.	Unit
Isolation Voltage	Input-output	Test time: 1min	3000	-	-	VAC
Operating Temperature			-25	-	+70	°C
Storage Temperature			-25	-	+105	
Storage Humidity			-	-	95	%RH
Welding Temperature	Wave-soldering		260±5°C; time:5~10s			
	Manual-welding		360±10°C; time:3~5s			
Switching Frequency	DZH05-10B/D series		-	-	140	kHz
	Other series		-	65	-	
Power Derating	-25°C~-10°C		2.5	-	-	%/°C
	55°C~+70°C		3.75	-	-	
Safety Standard	IEC60950/EN60950/UL60950					
Safety Certification	EN60950/UL60950					
Safety Class	DZH15-10BXX		CLASS II			
	Other series		CLASS I			
MTBF	MIL-HDBK-217F@25°C > 300,000 h					

PHYSICAL SPECIFICATIONS	
Casing Material	Black flame-retardant and heat-resistant plastic (UL94-V0)
Dimension	Refer to the Dimensions
Weight	Refer to the Dimensions
Cooling method	Free air convection

## DZH05-25 Series - 5-25W AC/DC Converter

**EMC SPECIFICATIONS**

EMI	CE	CISPR22/EN55022, CLASS B (Without External Circuit )	
	RE	CISPR22/EN55022, CLASS B (Without External Circuit )	
EMS	ESD	IEC/EN61000-4-2	$\pm 6\text{KV}/\pm 8\text{KV}$ perf. Criteria B
	RS	IEC/EN61000-4-3	10V/m perf. Criteria A
	EFT	IEC/EN61000-4-4	$\pm 2\text{KV}$ (Without External Circuit ) perf. Criteria B
		IEC/EN61000-4-4	$\pm 4\text{KV}$ (See Fig. 5 for recommended circuit) perf. Criteria B
EMS	Surge	IEC/EN61000-4-5	$\pm 1\text{KV}/\pm 2\text{KV}$ (Without External Circuit ) perf. Criteria B
		IEC/EN61000-4-5	$\pm 2\text{KV}/4\text{KV}$ (See Fig. 5 for recommended circuit) perf. Criteria B
	CS	IEC/EN61000-4-6	10 Vr.m.s perf. Criteria A
	PFM	IEC/EN61000-4-8	10A/m perf. Criteria A
	Immunities of voltage dip, drop and short interruption	IEC/EN61000-4-11	0%-70% perf. Criteria B

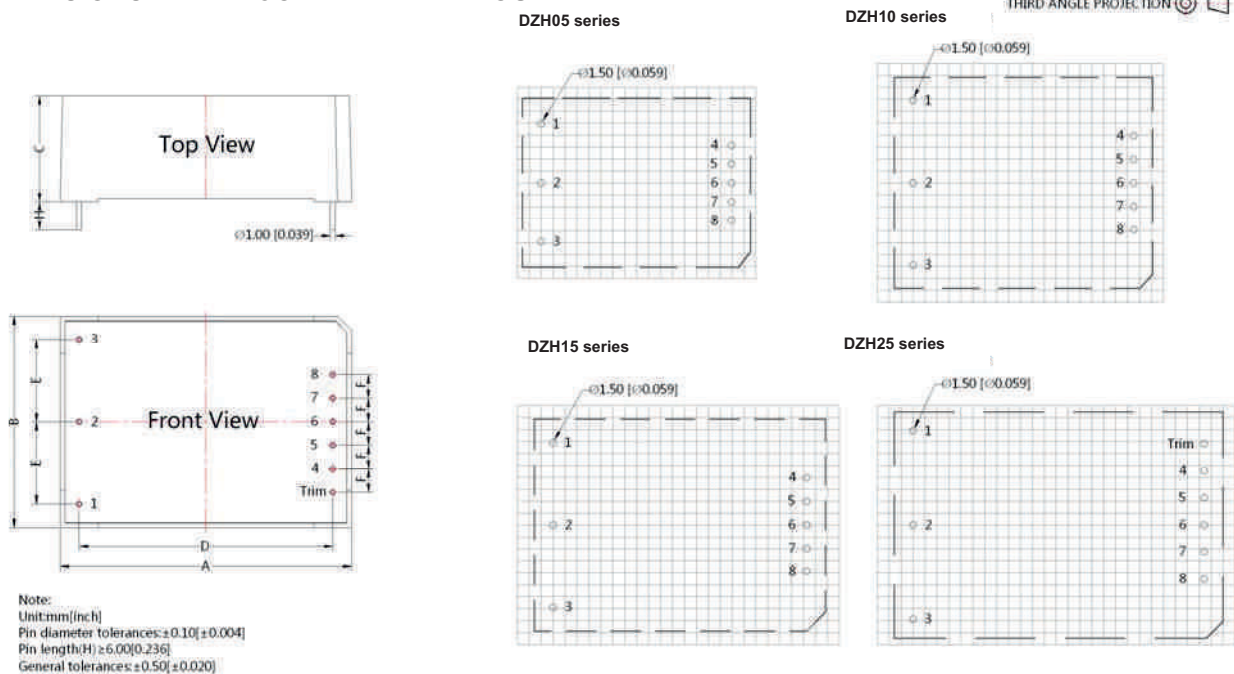
**MECHANICAL SPECIFICATIONS**
**DIMENSIONS AND RECOMMENDED LAYOUT**

Dimensions (Unit: mm)					
NO.	DZH05	DZH10	DZH15	DZH20	DZH25
A	48.50	55.00	62.00	70.00	70.00
B	36.00	45.00	45.00	48.00	48.00
C	20.50	21.00	22.50	23.50	23.50
D	40.50	47.00	54.00	62.00	62.00
E	12.50	17.50	17.50	20.00	20.00
F	4.00	5.00	5.00	5.75	5.75
G	10.00	12.50	12.50	12.50	12.50

Models Weight					
Weight (Typ.)	DZH05	DZH10	DZH15	DZH20	DZH25
	50g	80g	85g	120g	120g

Pin Connection				
Pin	DZHXX-10B	DZHXX-10A	DZHXX-10C	DZHXX-10D
1				
2	AC(N)	AC(N)	AC(N)	AC(N)
3	AC(L)	AC(L)	AC(L)	AC(L)
4	-Vo	-Vo	-Vo1	-Vo1
5	No Pin	No Pin	+Vo1	+Vo1
6	No Pin	COM	-Vo2	No Pin
7	No Pin	No Pin	COM	-Vo2
8	+Vo	+Vo	+Vo2	+Vo2
Trim	Trim**	No Pin	No Pin	No Pin

There is no pin "1" on DZH15-10BXX  
 Trim\*\*: only for DZH20/25-10BXX Series.

DZH05-25 Series - 5-25W AC/DC Converter

**MECHANICAL SPECIFICATIONS**

**DZHXXA2 DIMENSIONS**

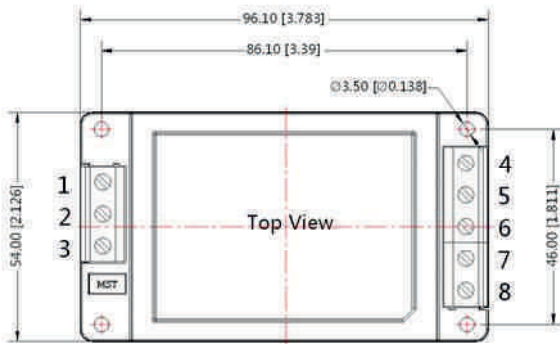

THIRD ANGLE PROJECTION

Pin	DZHXX-10B	DZHXX-10A	DZHXX-10C	DZHXX-10D
1				
2	AC(N)	AC(N)	AC(N)	AC(N)
3	AC(L)	AC(L)	AC(L)	AC(L)
4	-Vo	-Vo	-Vo1	-Vo1
5	NC	NC	+Vo1	+Vo1
6	NC/Trimm**	COM	-Vo2	NC
7	NC	NC	COM	-Vo2
8	+Vo	+Vo	+Vo2	+Vo2

There is no pin „1“, on DZH15-10BXXA2. NC/Trim\*\*;  
 The pin ins Trim on DZH20/25-10BXXA2,  
 The pin is not connected on other single output products.

\*The figure above is related to DZH15XXA2 series, the height of other series is different

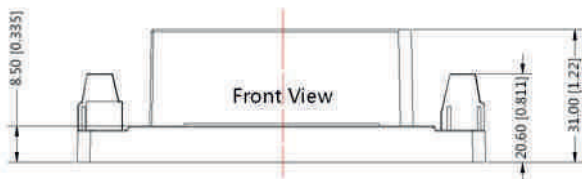

Note:  
 Unit: mm(inch)  
 Wire range: 24~12AWG  
 General tolerances: ± 0.50 [ ± 0.020]

Dimensions (Unit: mm)	
Model	Dimensions
DZH05XXA2	96.10*54.00*29.00
DZH10XXA2	96.10*54.00*29.50
DZH15XXA2	96.10*54.00*31.00
DZH20XXA2	96.10*54.00*32.00
DZH25XXA2	96.10*54.00*32.00

Models Weight					
Weight	DZH05	DZH10	DZH15	DZH20	DZH25
Typ.	100g	130g	135g	170g	170g

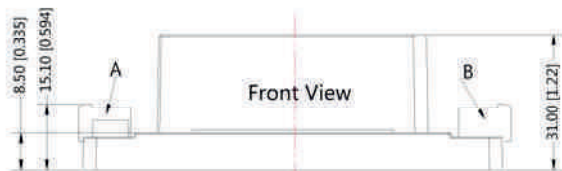
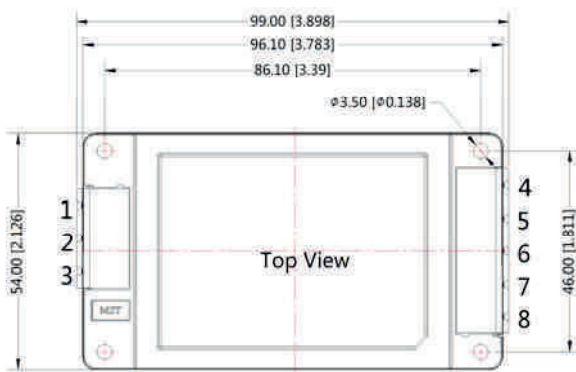

## DZH05-25 Series - 5-25W AC/DC Converter

**MECHANICAL SPECIFICATIONS**
**DZHXXA3 DIMENSIONS**

Outline and dimensions (Unit: mm)

Model	Dimensions
DZH05XXA3	99.00*54.00*29.00
DZH10XXA3	99.00*54.00*29.50
DZH15XXA3	99.00*54.00*31.00
DZH20XXA3	99.00*54.00*32.00
DZH25XXA3	99.00*54.00*32.00

THIRD ANGLE PROJECTION

Pin Connection				
Pin	DZHXX-10B	DZHXX-10A	DZHXX-10C	DZHXX-10D
1				
2	AC(N)	AC(N)	AC(N)	AC(N)
3	AC(L)	AC(L)	AC(L)	AC(L)
4	-Vo	-VO	-Vo1	-Vo1
5	NC	NC	+Vo1	+Vo1
6	NC/Trim**	COM	-Vo2	NC
7	NC	NC	COM	-Vo2
8	+Vo	+VO	+Vo2	+Vo2

There is no pin „1“, on DZH15-10BXXA3. NC/Trim\*\*;  
 The pin is Trim on DZH20/25-10BXXA3,  
 The pin is not connected on other single output products.

\*The figure above is related to DZH15XXA3 series, the height of other series is different

Note:

Unit: mm(inch)

 General tolerances:  $\pm 0.50 [\pm 0.020]$ 

A: DEGSON P/N: 2EDGRC -7.5-03P-14-100A (H)

B: DEGSON P/N: 2EDGRC -7.5-05P-14-100A (H)

Models Weight

Weight	DZH05	DZH10	DZH15	DZH20	DZH25
Typ.	100g	130g	135g	170g	170g

**DZHXXA4 DIMENSIONS**

THIRD ANGLE PROJECTION

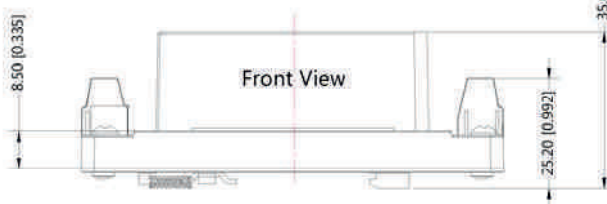
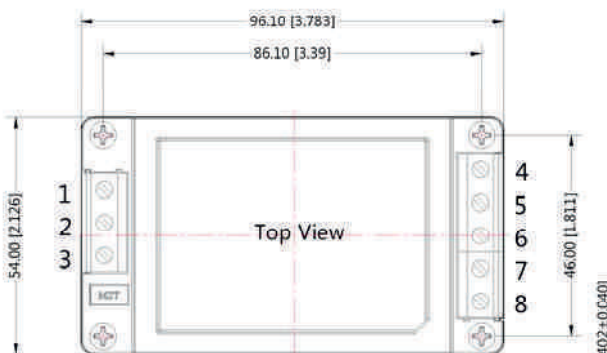

Pin Connection				
Pin	DZHXX-10B	DZHXX-10A	DZHXX-10C	DZHXX-10D
1				
2	AC(N)	AC(N)	AC(N)	AC(N)
3	AC(L)	AC(L)	AC(L)	AC(L)
4	-Vo	-VO	-Vo1	-Vo1
5	NC	NC	+Vo1	+Vo1
6	NC/Trim**	COM	-Vo2	NC
7	NC	NC	COM	-Vo2
8	+Vo	+VO	+Vo2	+Vo2

There is no pin „1“, on DZH15-10BXXA4. NC/Trim\*\*;  
 The pin is Trim on DZH20/25-10BXXA4,  
 The pin is not connected on other single output products.

\*The figure above is related to DZH15XXA4 series, the height of other series is different

Note:

Unit: mm(inch)

Wire range: 24~12AWG

 General tolerances:  $\pm 0.50 [\pm 0.020]$

## DZH05-25 Series - 5-25W AC/DC Converter

MODEL SELECTION GUIDE								
Certification	Part No.*	Output Power	Nominal Output Voltage and Current		Efficiency (230VAC, %/Typ.)	Max. Capacitive Load(μF)		
			(Vo1/Io1)	(Vo2/Io2)		Vo1	Vo2	
UL/CE	DZH05-10B03	4W	3,3V/1250mA	–	70	8100	–	
	DZH05-10B05	4W	5V/1000mA	–	75	6800	–	
	DZH05-10B09		9V/550mA	–	77	1200	–	
	DZH05-10B12		12V/420mA	–	79	1000	–	
	DZH05-10B15		15V/330mA	–	80	680	–	
	DZH05-10B24		24V/230mA	–	82	270	–	
DZH05-10A05	5W		+5V/500mA	-5V/500mA	75	1480	1480	
DZH05-10A12		+12V/210mA	-12V/210mA	79	130	130		
DZH05-10A15		+15V/160mA	-15V/160mA	79	110	110		
DZH05-10A24		+24V/100mA	-24V/100mA	80	16	16		
DZH05-10C0505-01		5V/800mA	±5V/100mA	70	2400	2400		
DZH05-10C0512-01		5V/600mA	±12V/100mA	73	1600	1600		
DZH05-10C0515-01		5V/600mA	±15V/80mA	74	1760	1760		
DZH05-10C0524-01		5V/600mA	±24V/50mA	75	1170	1170		
DZH05-10D0505-01		5V/900mA	5V/800mA	71	3360	3360		
DZH05-10D0512-01		5V/750mA	12V/400mA	73	370	370		
DZH05-10D0515-01		5V/700mA	15V/300mA	73	8800	8800		
DZH05-10D0524-01		5V/600mA	24V/200mA	75	3000	3000		
UL/CE		DZH05-10B03	6,6W	3,3V/2000mA	–	70	26400	–
		DZH05-10B05	10W	5V/2000mA	–	76	9440	–
	DZH05-10B09	9V/1100mA		–	78	3600	–	
	DZH05-10B12	12V/900mA		–	80	2400	–	
	DZH05-10B15	15V/700mA		–	81	1170	–	
	DZH05-10B24	24V/450mA		–	82	370	–	
	DZH05-10A05	+5V/1000mA		-5V/1000mA	76	8800	8800	
UL/CE	DZH10-10A12	10W		+12V/450mA	-12V/450mA	80	1970	1970
	DZH10-10A15		+15V/350mA	-15V/350mA	81	1970	1970	
	DZH10-10A24		+24V/200mA	-24V/200mA	84	660	660	
–	DZH10-10C0512-02		5V/1000mA	±12V/200mA	75	3200	260	
	DZH10-10C0515-02		5V/900mA	±15V/200mA	75	2160	80	
UL/CE	DZH10-10D0505-02		9.9W	5V/1800mA	5V/200mA	75	8000	540
	DZH10-10D0512-02			5V/1500mA	12V/200mA	79	4400	260
	DZH10-10D0515-02			5V/1400mA	15V/200mA	79	4400	170
	DZH10-10D0524-02			5V/1000mA	24V/200mA	81	4000	170
	DZH15-10B03			3,3V/3000mA	–	73	72000	–
	DZH15-10B05			5V/2800mA	–	76	44800	–
	DZH15-10B09			9V/1600mA	–	78	13760	–
	DZH15-10B12			12V/1250mA	–	80	5200	–
DZH15-10B15	15V/1000mA		–	80	5120	–		
DZH15-10B24	24V/625mA	–	84	880	–			
DZH15-10B48	48V/320mA	–	85	370	–			

## DZH05-25 Series - 5-25W AC/DC Converter

MODEL SELECTION GUIDE							
Certification	Part No.*	Output Power	Nominal Output Voltage and Current		Efficiency (230VAC, %/Typ.)	Max. Capacitive Load(μF)	
			(Vo1/Io1)	(Vo2/Io2)		Vo1	Vo2
UL/CE	DZH15-10B05		5V/2800mA	–	76	44800	–
	DZH15-10B09		9V/1600mA	–	78	13760	–
	DZH15-10B12		12V/1250mA	–	80	5200	–
	DZH15-10B15		15V/1000mA	–	80	5120	–
	DZH15-10B24		24V/625mA	–	84	880	–
	DZH15-10B48		48V/320mA	–	85	370	–
–	DZH15-10A05	15W	±5V/1500mA	-5V/1500mA	76	12800	12800
	DZH15-10A12		±12V/650mA	-12V/650mA	81	2350	2350
	DZH15-10A15		±15V/500mA	-15V/500mA	83	3120	3120
	DZH15-10A24		±24V/310mA	-24V/310mA	83	400	400
	DZH15-10C0505-05		5V/2000mA	±5V/500mA	75	10800	2160
	DZH15-10C0512-02		5V/2000mA	±12V/200mA	77	17280	2160
	DZH15-10C0515-02		5V/1800mA	±15V/200mA	78	5920	370
	DZH15-10C0524-01		5V/2000mA	±24V/100mA	78	1600	130
	DZH15-10D0505-08		5V/2200mA	5V/800mA	76	10800	2960
	DZH15-10D0512-04		5V/2000mA	12V/400mA	80	8640	1200
	DZH15-10D0515-03		5V/2000mA	15V/300mA	80	6480	800
	DZH15-10D0524-02		5V/2000mA	24V/200mA	81	12900	800
	UL/CE		DZH20-10B03	13.53W	3.3V/4100mA	–	73
DZH20-10B05			5V/3500mA	–	75	12240	–
DZH20-10B09			9V/2100mA	–	77	7200	–
DZH20-10B12			12V/1600mA	–	81	5400	–
DZH20-10B15			15V/1300mA	–	83	2720	–
DZH20-10B24			24V/850mA	–	85	1840	–
DZH20-10B48	48V/420mA		–	85	500	–	
–	DZH20-10A05	20W	+5V/2000mA	-5V/2000mA	75	8000	8000
	DZH20-10A12		+12V/830mA	-12V/830mA	82	960	960
	DZH20-10A15		+15V/650mA	-15V/650mA	83	880	880
	DZH20-10C0505-05		5V/2500mA	±5V/500mA	74	11200	4480
	DZH20-10C0512-04		5V/2000mA	±12V/400mA	75	16000	1600
	DZH20-10C0515-03		5V/2000mA	±15V/300mA	76	13520	370
	DZH20-10C0524-02		5V/2000mA	±24V/200mA	77	11200	370
	DZH20-10D0512-06		5V/2500mA	12V/600mA	75	32400	3250
	DZH20-10D0515-05		5V/2500mA	15V/500mA	76	28000	1980
	DZH20-10D0524-03		5V/2500mA	24V/300mA	77	28000	720
UL/CE	DZH25-10B03	13.53W	3.3V/2500mA	–	73	48000	–
UL/CE	DZH25-10B05	25W	5V/4100mA	–	74	12240	–
	DZH25-10B09		9V/2500mA	–	78	5600	–
	DZH25-10B12		12V/2100mA	–	82	5400	–
	DZH25-10B15		15V/1600mA	–	83	2400	–
	DZH25-10B24		24V/1100mA	–	85	1440	–
	DZH25-10B48		48V/500mA	–	87	500	–

Note: \*About DZH05-10AXX, we use Vo2 as sampling feedback; DZH10/15/20-10AXX, use both positive and negative output as sampling feedback; and all others use Vo1 as sampling feedback.

# DZH40 Series

## 40W AC/DC Converter

### Features

- Wide Input voltage range: 85~264VAC/120~370VDC
- Low standby power consumption: 0.5W, conversion efficiency up to 84%
- Output short circuit, over-current, over-voltage protection
- Meet IEC61000, UL60950 and EN60950 standards
- Can be equipped with wiring package or rail package uses

INPUT SPECIFICATIONS						
Item	Operating Conditions		Min.	Typ.	Max.	Unit
Input Voltage Range	AC input		85	--	264	VAC
	DC input		120	--	370	VDC
Input frequency			47	--	440	Hz
Input current	115VAC		--	--	1.0	A
	230VAC		--	--	0.6	
Inrush current	115VAC		--	30	--	
	230VAC		--	50	--	

OUTPUT SPECIFICATIONS						
Item	Operating Conditions		Min.	Typ.	Max.	Unit
Output Voltage Accuracy	DZH40-10BXX	Main output	-	±2	-	%
	DZH40-10AXX	Main output / Secondary output	-	±2	-	
	DZH40-10DXX	Main output	-	±2	-	
	DZH40-10CXX	Secondary output	-	±5	-	
Line Regulation	DZH40-10BXX		-	±0.5	-	%
	DZH40-10AXX					
	DZH40-10DXX(Main output)					
	DZH40-10CXX(Main output)		-	±1.5	-	
	DZH40-10DXX(Secondary output)					
	DZH40-10CXX(Secondary output)					
Load Regulation	DZH40-10BXX		-	±1	-	%
	DZH40-10AXX(Balance load)		-	±2	-	
	DZH40-10DXX(Balance load)	Main output	-	±2	-	
		Secondary output	-	±5	-	
	DZH40-10CXX(Balance load)	Main output	-	±3	-	
		Secondary output	-	±5	-	
Output Ripple & Noise*	20MHz bandwidth (peak-peak value)		-	50	100	mV
Temperature Drift	Main output		-	±0.02	-	%/°C
Stand-by Power			-	-	0.5	W
Short Circuit Protection			Continuous, self-recovery			
Over-current Protection			≥110%Io self-recovery			
Over-voltage Protection	3.3V Output		-	-	5.5	V
	5V Output		-	-	9	
	9V Output		-	-	14	
	12V Output		-	-	20	
	15V Output		-	-	24	
	24V Output		-	-	35	

## DZH40 Series - 40W AC/DC Converter

**OUTPUT SPECIFICATIONS**

Min. Load	DZH40-10BXX		0	-	-	
	DZH40-10AXX (Balance load)		10	-	-	
	DZH40-10DXX (Balance load)		25	-	-	
	DZH40-10CXX (Balance load)		25	-	-	
Cross Regulation	DZLH40-10AXX		-	±5	-	%
	DZLH40-10DXX	Main output	-	±1	-	
		Secondary output	-	±7	-	
	DZH40-10CXX	Main output	-	±3	-	
Secondary output		-	±7	-		
Trim	DZLH40-10BXX		-	-	±10	
Hold-up Time	115VAC input		-	15	-	ms
	230VAC input		-	80	-	

Note: \* Ripple and noise tested with "parallel cable" method, please see *AC-DC Converter Application Notes* for specific operation methods.

**GENERAL SPECIFICATIONS**

Item	Operating Conditions	Min.	Typ.	Max.	Unit
Isolation Voltage	Input-output	3000	-	-	VAC
Operating Temperature	Test time: 1min	-40	-	+70	°C
Storage Temperature		-40	-	+85	
Storage Humidity		-	-	95	%RH
Welding Temperature	Wave-soldering	260 ±5°C; time:5~10s			
	Manual-welding	360 ±10°C; time: 3~5s			
Switching Frequency		--	65	--	kHz
Power Derating	-40°C to -30°C (LH40-10B03/05)	4.0	--	--	% / °C
	-40°C to -30°C (LH40-10B09/12/15)	3.0	--	--	
	-40°C to -30°C (LH40-10Dxx, LH40-10Axx, LH40-10Cxx)	5.0	--	--	% / °C
	+45°C to +70°C (LH40-10B03/05)	3.0	--	--	
	+55°C to +70°C (LH40-10B09/12/15)	3.7	--	--	
	+55°C to +70°C (LH40-10B24)	2.7	--	--	
+50°C to +70°C (LH40-10Dxx, LH40-10Axx, LH40-10Cxx)	3	--	--		
Safety Standard	IEC60950/EN60950/UL60950				
Safety-regulated Certification	EN60950/UL60950				
Safety Class	CLASS II				
Hot Plug	Unavailable				
MTBF	MIL-HDBK-217F@25°C > 300,000 h				

**PHYSICAL SPECIFICATIONS**

Casing Material	Black flame-retardant and heat-resistant plastic (UL94-V0)	
Package Dimensions	Horizontal package	109.00*58.50*30.00 mm
	A5 wiring package	135.00*70.00*33.50 mm
	A6 rail package	137.00*70.00*39.00 mm
Weight	Horizontal package/A5 wiring package/A6 rail package	
Cooling Method	225.00g/310.00g/370.00g(Typ.)	
	Free air convection	

DZH40 Series - 40W AC/DC Converter

EMC SPECIFICATIONS				
EMI	Conducted Disturbance	CISPR22/EN55022, CLASS B		
	Radiated Emission	CISPR22/EN55022, CLASS B		
EMS	Electrostatic Discharge	IEC/EN61000-4-2	±6KV/8KV	perf. Criteria B
	Radiation Immunity	IEC/EN61000-4-3	10V/m	perf. Criteria A
	EFT	IEC/EN61000-4-4	±4KV (Bare component)	perf. Criteria B
		IEC/EN61000-4-4	±4KV (See Fig. 5 for recommended circuit)	
	Surge Immunity	IEC/EN61000-4-5	±1KV/2KV (Bare component)	perf. Criteria B
		IEC/EN61000-4-5	±2KV/4KV (See Fig. 5 for recommended circuit)	
	Conducted Disturbance immunity	IEC/EN61000-4-6	10 Vr.m.s	perf. Criteria A
Immunity for Power frequency magnetic field	IEC/EN61000-4-8	10A/m	perf. Criteria A	
Immunities of voltage dip, drop and short interruption	IEC/EN61000-4-11	0%-70%	perf. Criteria B	

MECHANICAL SPECIFICATIONS

DIMENSIONS AND RECOMMENDED LAYOUT

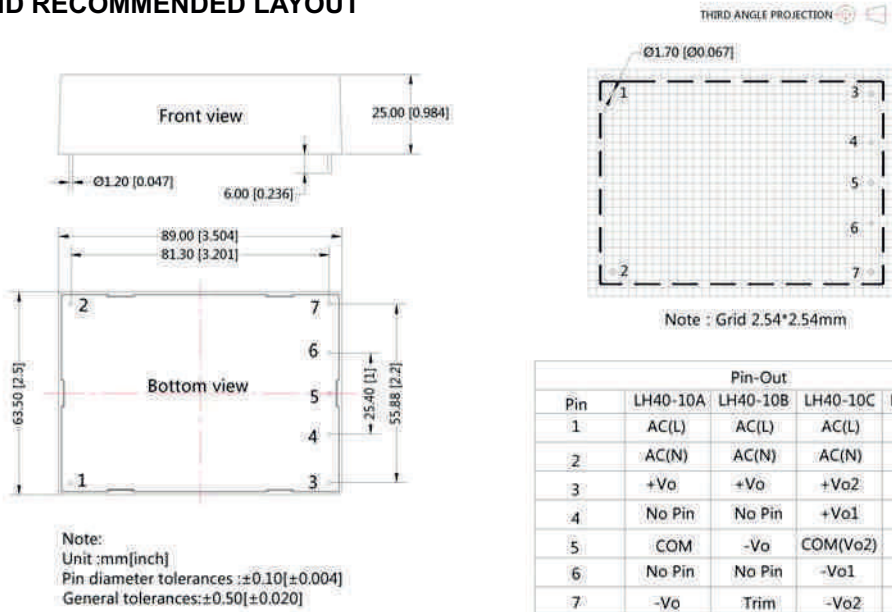

A5 WIRING PACKAGE DIMENSIONS

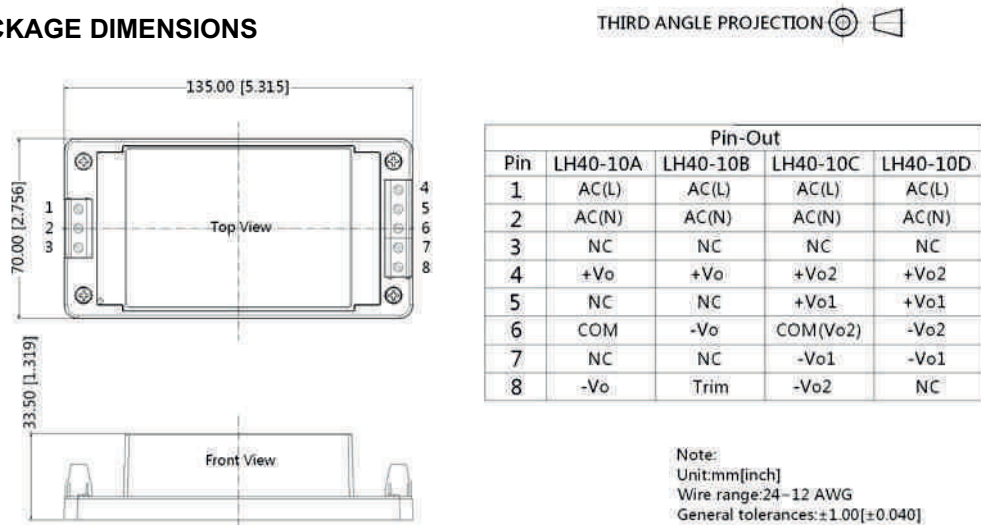

## DZH40 Series - 40W AC/DC Converter

**MECHANICAL SPECIFICATIONS**
**A6 RAIL PACKAGE DIMENSIONS**

THIRD ANGLE PROJECTION

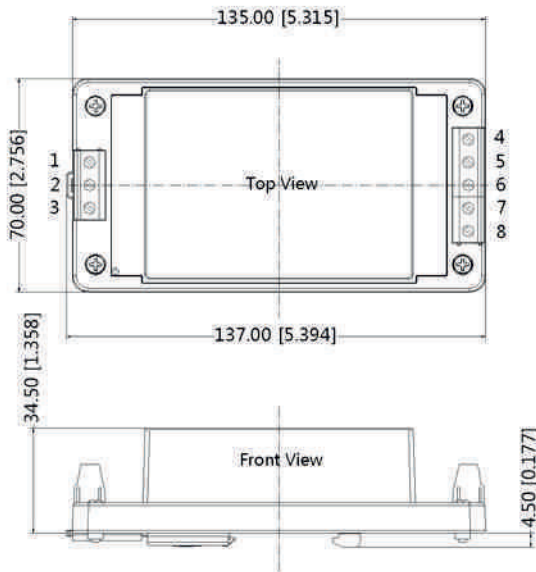

Pin-Out				
Pin	LH40-10A	LH40-10B	LH40-10C	LH40-10D
1	AC(L)	AC(L)	AC(L)	AC(L)
2	AC(N)	AC(N)	AC(N)	AC(N)
3	NC	NC	NC	NC
4	+Vo	+Vo	+Vo2	+Vo2
5	NC	NC	+Vo1	+Vo1
6	COM	-Vo	COM(Vo2)	-Vo2
7	NC	NC	-Vo1	-Vo1
8	-Vo	Trim	-Vo2	NC

Note:  
 Unit:mm[inch]  
 Installed on DIN RAIL TS35  
 Wire range:24-12 AWG  
 General tolerances:±1.00[±0.040]

**MODEL SELECTION GUIDE**

Certification	Part No.*	Output Power	Nominal Output Voltage and Current		Efficiency (230VAC, %/Typ.)	Max. Capacitive Load(µF)
			(Vo1/Io1)	(Vo2/Io2)		
UL/CE	DZH40-10B03	40W	3,3VDC/8000mA	-	78	60000
	DZH40-10B05		5VDC/8000mA	-	82	40000
	DZH40-10B09		9VDC/4444mA	-	84	12000
	DZH40-10B12		12VDC/3333mA	-	84	9000
	DZH40-10B15		15VDC/2666mA	-	84	7000
	DZH40-10B24		24VDC/1667mA	-	84	20000
--	DZH40-10D0512-13	40W	5VDC/5000mA	12VDC/1250mA	82	10000/470
	DZH40-10D0524-06		5VDC/5000mA	24VDC/625mA	82	10000/400
	DZH40-10A05		+5VDC/4000mA	-5VDC/4000mA	82	±12000
	DZH40-10A12		+12VDC/1666mA	-12VDC/1666mA	84	±4400
	DZH40-10A15		+15VDC/1333mA	-15VDC/1333mA	84	±1000
	DZH40-10C0512-06		5VDC/5000mA	±12VDC/600mA	82	10000/±900
	DZH40-10C0515-05		5VDC/5000mA	±15VDC/500mA	82	10000/±780

Note:\*product model with a suffix of „A5" means chassis mounting and that with a suffix of „A6" Indicates DIN-RAIL mounting (e.g. DZH40-10B05A5 means chassis mounting; DZH40-10B05A6 means DIN-RAIL mounting).

# DZH60 Series

## 60W AC/DC Converter

### Features

- Wide input voltage range: 90~264VAC/120~370VDC
- Low standby power consumption: 0.5W, conversion efficiency up to 86%, 4k VAC high safety isolation
- Output short circuit, over-current, over-voltage protection
- Meets IEC61000, UL60950, EN60950 standards
- Can be equipped with wiring package or rail package uses

INPUT SPECIFICATIONS						
Item		Operating Conditions	Min.	Typ.	Max.	Unit
Input Voltage Range	DZH60-20BXX DZ60-20BXX-DT	AC input	90	–	264	VAC
		DC input	120	–	370	VDC
Input frequency			47	–	63	Hz
Input current		115VAC	–	–	1,4	A
		230VAC	–	–	0,7	
Inrush current		115VAC	–	30	–	
		230VAC	–	50	–	
Input under-voltage protection	Start-up Voltage	AC input	65	–	90	VAC
		DC input	92	–	122	VDC
	Shutdown Voltage	AC input	55	–	75	VAC
		DC input	79	–	105	VDC

Note: \*DZH60-20BXX-DT series has no input under-voltage protection.



OUTPUT SPECIFICATIONS						
Item		Operating Conditions	Min.	Typ.	Max.	Unit
Output Voltage Accuracy			–	±2	–	%
Line Regulation		Full load	–	±0,5	–	
Load Regulation		5%-100% load	–	±1	–	
Output Ripple & Noise*		20MHz bandwidth (peak-peak value)	–	–	150	mV
Temperature Drift Coefficient			–	±0,02	–	%/°C
Stand-by Power Consumption			–	–	0,5	W
Short Circuit Protection			Continuous, self-recovery			
Over-current Protection			≥110%Io self-recovery			
Over-voltage Protection			Zener clamp diode			
Min. Load				–	–	%
Trim			–	–	–	
Hold-up Time		115VAC input	–	15	–	ms
		230VAC input	–	80	–	

Note: \* Ripple and noise tested with "parallel cable" method, please see *AC-DC Converter Application Notes* for specific operation methods.

PHYSICAL SPECIFICATIONS		
Casing Material		Black flame-retardant and heat-resistant plastic (UL94-V0)
Package Dimensions	Horizontal package	109,00*58,50*30,00mm
	A5 wiring package	135,00*70,00*38,50mm
	A6 rail package	137,00*70,00*44,00mm
Weight	Horizontal package/A5 wiring package/A6 rail package	310,00g(Typ.)
Cooling Method		Free air convection



## DZH60 Series - 60W AC/DC Converter

GENERAL SPECIFICATIONS						
Item	Operating Conditions		Min.	Typ.	Max.	Unit
Isolation Voltage	Input-output	Test time: 1min	4000	-	-	VAC
	Input- 		1500	-	-	
	Output- 		500	-	-	
Operating Temperature			-40	-	+70	°C
Storage Temperature			-40	-	+85	
Storage Humidity			-	-	95	%RH
Welding Temperature	Wave-soldering	260 ± 5°C; time: 5~10s				
	Manual-welding	360 ± 10°C; time: 3~5s				
Switching Frequency			-	100	-	kHz
Power Derating	-40°C to -30°C		4,0	-	-	%°C
	+45°C to +70°C (5V,9V output)		3,0	-	-	
	+50°C to +70°C (12V,15V output)		2,5	-	-	
	+55°C to +70°C (24V,48V output)					
Safety Standard			IEC60950/EN60950/UL60950			
Safety-regulated Certification			EN60950/UL60950			
Safety Class			CLASS I			
Hot Plug			Unavailable			
MTBF			MIL-HDBK-217F@25°C > 300.000h			

EMC SPECIFICATIONS			
EMI	Conducted Disturbance	CISPR22/EN55022, CLASS B	
	Radiated Emission	CISPR22/EN55022, CLASS B	
EMS	Electrostatic Discharge	IEC/EN61000-4-2 ±6KV/8KV	perf. Criteria B
	Radiation Immunity	IEC/EN61000-4-3 10V/m	perf. Criteria B
	EFT	IEC/EN61000-4-4 ±4KV	perf. Criteria B
	Surge Immunity	IEC/EN61000-4-5 ±2KV/4KV	perf. Criteria B
		IEC/EN61000-4-5 ±4KV/6KV (See Fig. 2 for recommended circuit)	perf. Criteria B
	Conducted Disturbance immunity	IEC/EN61000-4-6 10 Vr.m.s	perf. Criteria B
	Immunity for Power frequency magnetic field	IEC/EN61000-4-8 10A/m	perf. Criteria B
Immunities of voltage dip, drop and short interruption	IEC/EN61000-4-11 0%-70%	perf. Criteria B	

MODEL SELECTION GUIDE					
Certification	Part No.*	Output Power	Nominal Output Voltage and Current(Vo/Io)	Efficiency (230VAC, %/Typ.)	Max. Capacitive Load (µF)
UL/CE	DZH60-20B05	50W	5V/10A	82	80000
	DZH60-20B05-DT				
	DZH60-20B09	60W	9V/6.6A	84	28000
	DZH60-20B09-DT				
	DZH60-20B12		12V/5A	86	14000
	DZH60-20B12-DT		15V/4A	86	12000
	DZH60-20B15				
	DZH60-20B15-DT		24V/2.5A	86	4000
	DZH60-20B24				
	DZH60-20B24-DT				
	DZH60-20B48				
	DZH60-20B48-DT				

Note:1.\* There isn't input under voltage protection for „DZH60-20BXX-DT“ series.

2.\* product model with a suffix of „A5“ means chassis mounting and that with a suffix of „A6“ Indicates DIN-RAIL mounting (e.g. DZH60-20B05A5 means chassis mounting; DZH60-20B05A6 means DIN-RAIL mounting).

DZH60 Series - 60W AC/DC Converter

**MECHANICAL SPECIFICATIONS**

**DIMENSIONS AND RECOMMENDED LAYOUT**

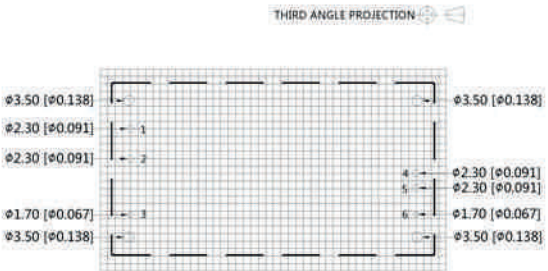
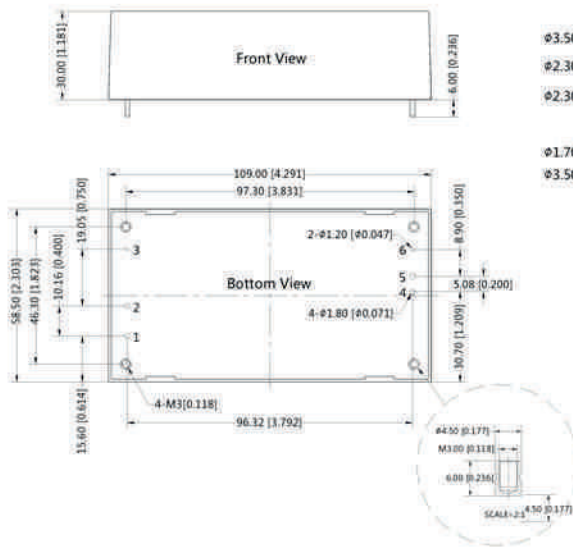

Note : grid : 2.54\*2.54mm

Pin-Out	
Pin	Function
1	AC(N)
2	AC(L)
3	⏏
4	+Vo
5	-Vo
6	Trim

Note:  
 Unit:mm[inch]  
 Pin 1,2,4,5's diameter:1.80[0.071],pin 3,6's diameter:1.20[0.047]  
 Pin diameter tolerances:±0.10[±0.004]  
 Pin tolerances(H):±1.00[±0.040]  
 General tolerances:±0.50[±0.020]  
 This serie of products need to fix screws in a had vibration

**A5 WIRING PACKAGE DIMENSIONS**

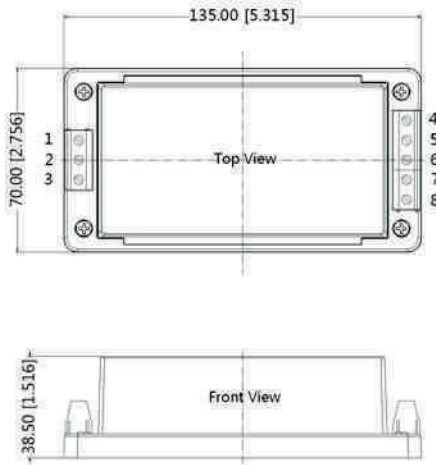

THIRD ANGLE PROJECTION

Pin-Out	
Pin	Function
1	AC(N)
2	AC(L)
3	⏏
4	NC
5	NC
6	+Vo
7	-Vo
8	Trim

Note:  
 Unit:mm[inch]  
 Wire range:24-12 AWG  
 General tolerances:±1.00[±0.040]

**A6 RAIL PACKAGE DIMENSIONS**

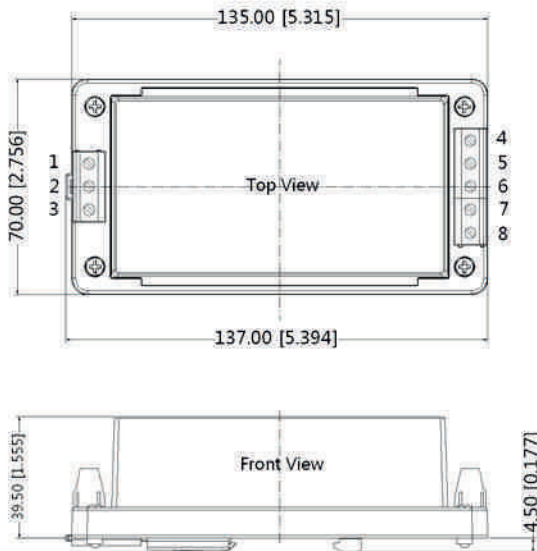

THIRD ANGLE PROJECTION

Pin-Out	
Pin	Function
1	AC(N)
2	AC(L)
3	⏏
4	NC
5	NC
6	+Vo
7	-Vo
8	Trim

Note:  
 Unit:mm[inch]  
 Installed on DIN RAIL TS35  
 Wire range:24-12 AWG  
 General tolerances:±1.00[±0.040]